

FlashForge Dreamer 3D Printer User Guide



Content

Content.....	2
Introduction.....	4
Notice.....	5
Chapter 1: 3D Printing Technology.....	8
1.1 Process.....	8
Chapter 2 . About Dreamer.....	10
2.1 About Your Dreamer.....	10
Chapter 3. Unpacking.....	14
Chapter 4 . Hardware Assembly.....	17
4.1 Mounting the Extruder Set.....	17
4.2 Installing Filament.....	19
4.3 Plugging in Power Cable&USB Cable.....	20
4.4 Loading and Unloading Filament.....	20
Chapter 5: Build Plate Leveling.....	24
Chapter 6: About Software.....	27
6.1 Software Installation.....	27
6.2 Exploring FlashPrint.....	28
Chapter 7: Basic Printing.....	51
7.1 Single-Extrusion and Dual-Extrusion Print.....	51
7.2 Methods of printing.....	57
Chapter 8: Supports and Service.....	61

Preface

Note: Each device must be tested before leaving factory. If there are some residues in extruder or some tiny scratches on the build tape, it is normal and won't affect the printing quality.

On the completion of this User Guide, thanks all FlashForge engineers and the FlashForge 3D printer users for their unremitting efforts and sincere assistance.

The FlashForge Dreamer User Guide is designed for the Dreamer users to start their printing journey with FlashForge Dreamer. Even if you are familiar with earlier FlashForge machines or 3D printing technology, we still recommend that you read through this guide, as there is lots of important information about the Dreamer for you to get a better 3D experience.

For a better and more successful printing experience, you can refer to the following materials:

(1) Quick Start Guide

Users will find the Quick Start Guide together with the printer accessories. The Quick Start Guide will help you start your print journey as soon as possible.

(2) Official FlashForge Website: <http://www.FlashForge.com>

The official FlashForge website contains the up-to-date information concerning FlashForge software, firmware, device maintenance and so on. Users are also able to get the contact information from there.

Introduction

Notes:

- Please read *FlashForge Dreamer 3D Printer User Guide* carefully before use.
- The User Guide is written based on Windows 7 OS.
- The version of the FlashPrint is the latest.

The *FlashForge Dreamer 3D Printer User Guide* contains the information needed for you to set up and use this device.

This User Guide includes the following parts: Preface, Introduction and After-sales service.

The Preface section includes resource acquisition channel, the overall framework of the manual, and the problems that should be paid attention to.

The introduction section contains the presentation of 3D printing technology, equipment introduction, unpacking and installation of equipment, software installation and usage.

After-sales section covers how to get the support and help.

Notice

Safety Notice

! Notices: Read all the instructions in the manual and familiarize yourself with the FlashForge Dreamer User Guide before setting-up and using. Failure to comply with the warning and instructions may result in individual injury, fire, equipment damage or property damage.

PLEASE STRICTLY FOLLOW ALL THE SAFETY WARNINGS AND NOTICE BELOW ALL THE TIME.

• Work Environment Safety

- ① Keep your work place tidy.
- ② Do not operate Dreamer in the presence of flammable liquids, gases or dust.
- ③ Dreamer should be placed out of children and untrained people's reach.

• Electricity Safety

- ① Always use the Dreamer with a properly grounded outlet. Do not refit Dreamer's plug.
- ② Do not use Dreamer in damp or wet locations. Do not expose Dreamer to burning sun.
- ③ In case of device damage, please use the power supply provided by FlashForge..
- ④ Avoid using the device during an thunderstorm.
- ⑤ In case of uncertain accident, please unplug the device if you do not use it for long.

• Personal Safety

- ① Do not touch the nozzle and build plate during printing.

- ② Do not touch the nozzle after finishing printing.
- ③ Dress properly. Do not wear loose clothing or jewelry. Keep your hair, clothing and gloves away from moving parts.
- ④ Do not operate the device while you are tired or under the influence of drugs, alcohol or medication.

- **Cautions**

- ① Do not leave the device unattended for long.
- ② Do not make any modifications to the device.
- ③ To lower the build plate before loading/unloading filament. (The distance between the nozzle and build plate should be kept for at least 50mm)
- ④ Operate the device in a well-ventilated environment.
- ⑤ Never use the device for illegal activities.
- ⑥ Never use the device to make any food storage vessels.
- ⑦ Never use the device to make any electrical appliance.
- ⑧ Never put the model into your mouth.
- ⑨ Do not remove the models with force.

- **Environment Requirements**

Temperature: RT 15-30°C

Moisture: 20%-70%

- **Place Requirements**

The device must be placed in a dry and ventilated environment. The distances of the left, right and back side space should be at least 20cm, and the distance of the front side space should be at least 35cm.

- **Filament Requirements**

Do not abuse the filament. Please make sure you use the FlashForge filament or the filament from the brands accepted by FlashForge.

- **Filament Storage**

All polymers degrade with time. Do not unpack until filament is needed. Filament should be stored in clean and dry conditions.

Legal Notice

All the information in this document is subject to any amendment or change without the official authorization from FlashForge.

FLASHFORGE CORPORATION MAKES NO WARRANTY OF ANY KIND WITH REGARD TO THIS DOCUMENT, INCLUDING, BUT NOT LIMITED TO, THE IMPLIED WARRANTIES OF MERCHANTABILITY AND FITNESS FOR A PARTICULAR PURPOSE.

FlashForge shall not be liable for errors contained herein for incidental consequential damages in connection with furnishing, performance or use of this material

This document contains proprietary information protected by copyright.
Copyright © 2017 FlashForge Corp. All Rights Reserved

Chapter 1: 3D Printing Technology

3D printing refers to transforming three-dimensional models into physical objects that you can hold and touch. It is also called additive manufacturing because the 3D model is created by “adding” layers upon layers of material until the object is fully formed.

Fused Filament Fabrication (FFF) is the most common method of 3D printing. It is also the method that the Dreamer uses. It works by melting plastic material called filament onto a print surface in high temperature. The filament solidifies after it cools down, which happens instantaneously after it is extruded from the nozzle. 3D objects are formed with the filament laying down multiple layers.

1.1 Process

3D printing involves three steps:

- 1.) Make or download a 3D model
- 2.) Slice and export the 3D model
- 3.) Build the 3D model

1.1.1 Make a 3D Model

Currently, there are three ways of creating a 3D model.

- **Designing From Scratch** You can use free CAD (computer-aided design) software such as 3DTADA, AutoCAD, SolidWorks, Pro-E, and our own software Happy 3D, which is suitable for the beginners, to design your own 3D model.

- **3D Scanners** An alternative method to creating a 3D model is to scan an object. 3D scanners work by digitizing a physical object, collecting its geometric data, and saving it to a file on your PC. There are also apps that can turn a mobile device into a 3D

scanner.

- **From the Cloud** The most popular way of obtaining a 3D model is to download it from websites that allow users to upload 3D models that they designed.

E.g. www.thingiverse.com

1.1.2 Slice and Export the 3D Model

Slice software is the software that prepares 3D models for printing and turns them into instructions for the 3D printers. FlashPrint is the slicing software used for the FlashForge Dreamer.

Using FlashPrint, you can prepare .stl files to be .g or .gx files for printing. Then the files can be transferred to your Dreamer via USB cable, USB stick or WiFi.

1.1.3 Build the 3D Model

Once the output file has been transferred to your Dreamer, it will start to turn the 3D model into a physical object by laying down layers of filament.

Chapter 2 . About Dreamer

2.1 About Your Dreamer

2.1.1 Main view:

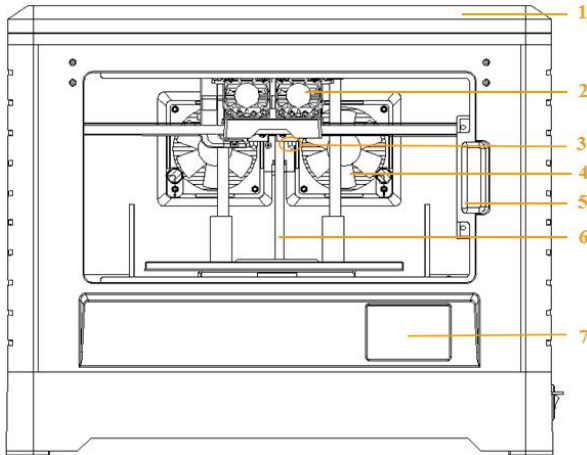

1. Lid
2. Cooling fan
3. Nozzle
4. Ventilating fan
5. Front door
6. Z axis guide rod
7. Touch screen
8. Build plate
9. Filament slot
10. X axis guide rod
11. Timing belt
12. Spring presser
13. Filament intake
14. Turbofan
15. Side panel
16. SD card slot
17. Power switch
18. Power input
19. Reset button
20. USB cable input

Top view:

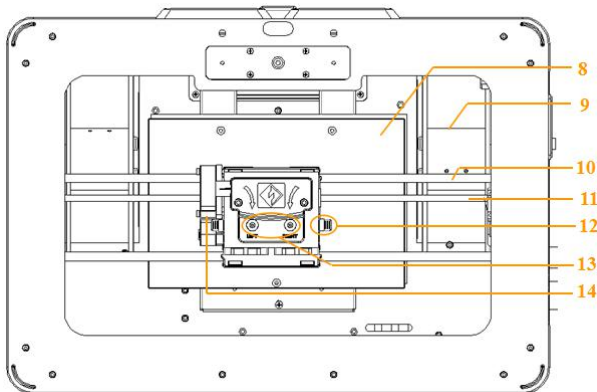

8. Build plate
9. Filament slot
10. X axis guide rod
11. Timing belt
12. Spring presser
13. Filament intake
14. Turbofan
15. Side panel
16. SD card slot
17. Power switch
18. Power input
19. Reset button
20. USB cable input

Left view:

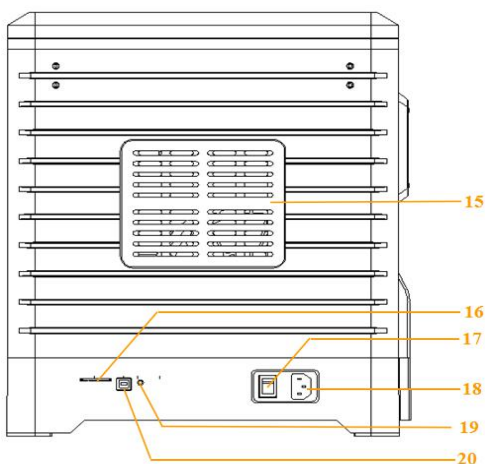

15. Side panel
16. SD card slot
17. Power switch
18. Power input
19. Reset button
20. USB cable input

2.1.2 Accessory Box



Filament*2

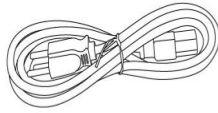

Power Cable



USB Cable

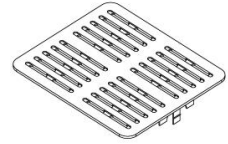

Side Panel*2

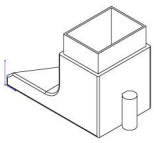

Turbofan Baffle



Tool Box



Build Tape



Quick Start Guide

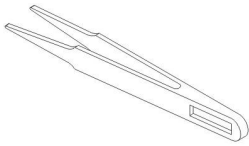

Tweezers

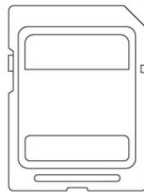

SD Card



Leveling Card



Screwdriver



Scraper



Screw Box



Carving Knife

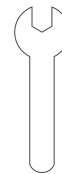

Stamping Wrench

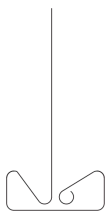

Unclogging Pin Tool



Allen wrench

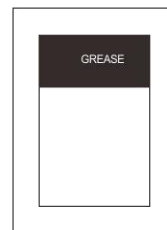

Grease

2.1.3 Terms

Build Plate	The surface on which the Dreamer builds an object.
Build Tape	The blue tape that covers Dreamer's build plate so that the object can adhere to the build plate well.
Build Volume	The three dimensional amount of space that an object will use once it is completed. The largest build volume of Dreamer is 230*150*140mm.
Leveling Knobs	Knobs under the build platform that are used for adjusting the distance between the nozzle and build plate.
Extruder	The device that draws the filament from the spool, melts it and pushes it through a nozzle onto the build plate.
Nozzle	Also called "print head", which located at the bottom of the extruder where heated filament is squeezed out.
Cooling Fan	To cool the outer assembly of the extruder and gear motor.
Filament Intake	An opening located at the top of the extruder .
Filament Guide Tube	A plastic piece that guides the filament from the filament box to the filament intake.
Unclogging Pin Tool	A tool that used for cleaning and unclogging the extruder.
Stamping Wrench	A tool that used for seizing the nozzle's metal cube.

2.1.4 Reference

Name	Dreamer
Number of Extruder	2
Print Technology	Fused Filament Fabrication(FFF)
Screen	3.5" color IPS Touch Screen
Print Accuracy	±0.1mm
Positioning Accuracy	Z axis 0.0025mm; XY axis 0.011mm
Layer Resolution	0.05-0.4mm
Build Volume	230*150*140mm
Nozzle Diameter	0.4mm
Build Speed	10~200mm/s
Maximum Extruder Temperature	240°C
Filament Diameter	1.75mm (±0.07)
Filament Types	ABS/PLA/Conductive PLA/Flexible Filament
Software	FlashPrint
Support Formats	3MF/STL/OBJ/FPP/BMP/PNG/JPG/JPEG; GX/G
OS	Win xp/Vista/7/8/10、 Mac OS、 Linux
AC Input	100-240V~/4.5A-2.5A
Device Size	485*344*382(402)mm
Net Weight	10.7Kg
Connectivity	USB cable, SD card, WiFi

Chapter 3. Unpacking

(Reference video:[Unpacking](#))

This chapter will present you the whole unpacking procedure of Dreamer 3D printer. **(Note: Make sure you read the whole unpacking guide)**

1. (3-1) Put Dreamer package on the clean, tidy workbench, using a knife to cut the tape, then you can see a quick start guide, which will guide you know our Dreamer 3D Printer, leveling card, and build tape.



3-1

2. (3-2) Remove the top protective foam pieces, which also houses the Dreamer's lid and put them aside. The Dreamer unit and a power cable will then be exposed.



3-2

3. (3-3) Firmly grasp the two side handles of FlashForge Dreamer. Lift it out of the box and place it on a stable surface. Then you will see the **Toolbox** and **USB cable** in

the shipping box. **In the Toolbox, you can find a Carving Knife, a Scraper, a bag of Grease, Tweezers and a Screw Box, which contains a SD card and some screws, Wrenches.**

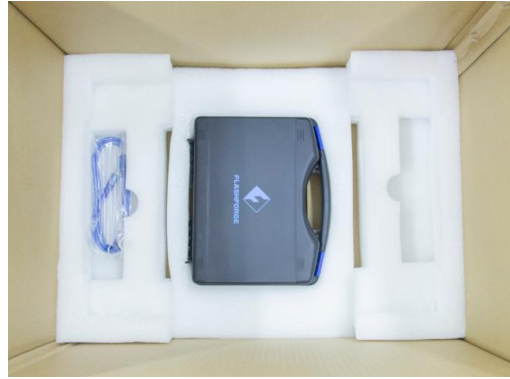

3-3

4. (3-4) You can find an accessory box on top of Dreamer, which houses the extruder set. Remove the box and the foam sheet from the Dreamer, and gently lay the extruder set on the Dreamer build plate.

Inside the accessory box, you will find a **dual-extruder, a turbofan baffle, and two pieces of removable side panels.**



3-4

5. (3-5) Elevate the build plate up carefully.

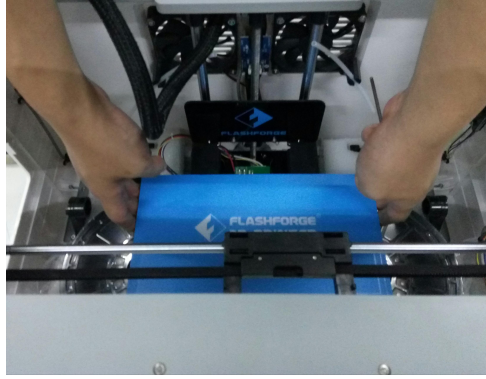

3-5

6. (3-6)Take out the PLA filament and ABS filament carefully which is under the build plate.

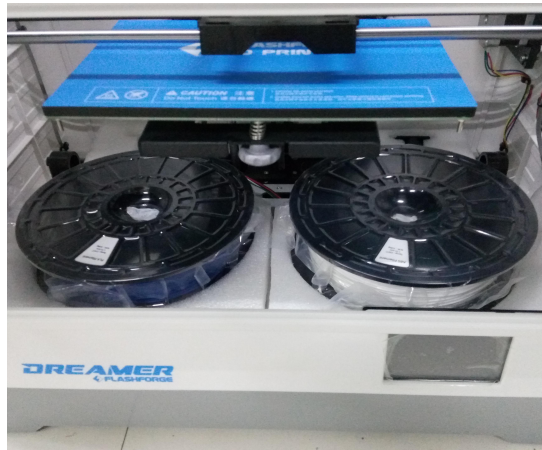

3-6

(3-7)You've finished unpacking your Dreamer. Next we will move on to the hardware assembly.



3-7

Chapter 4 . Hardware Assembly

The Dreamer comes pre-assembled and is almost ready-to-print (ARP). All you need to do is to mount the extruder set, and install the filament. It will only take 5 to 10 minutes to start up the Dreamer and prepare for your first 3D print!

4.1 Mounting the Extruder Set

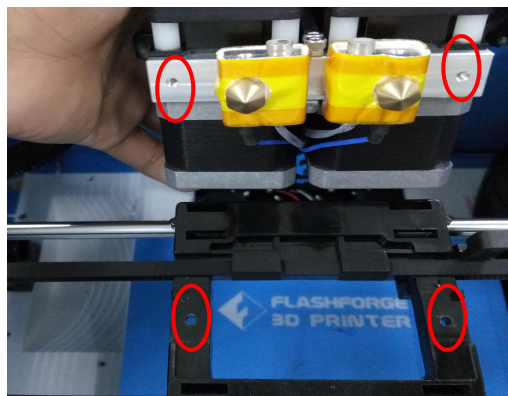

4-1

(4-1) Lay the extruder module on the top of the extruder support with the two extruder fans facing the front.

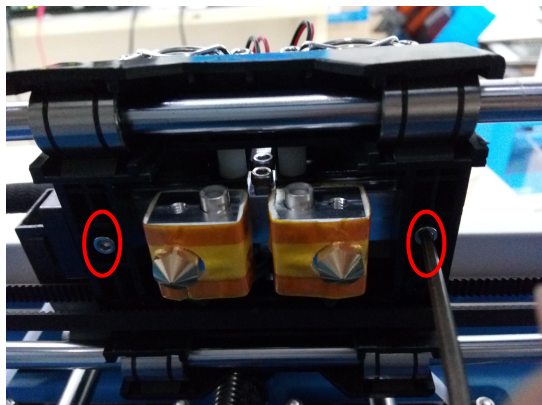

4-2

(4-2) Fix the extruder module onto the extruder support with two M3x12 screws from the bottom up.

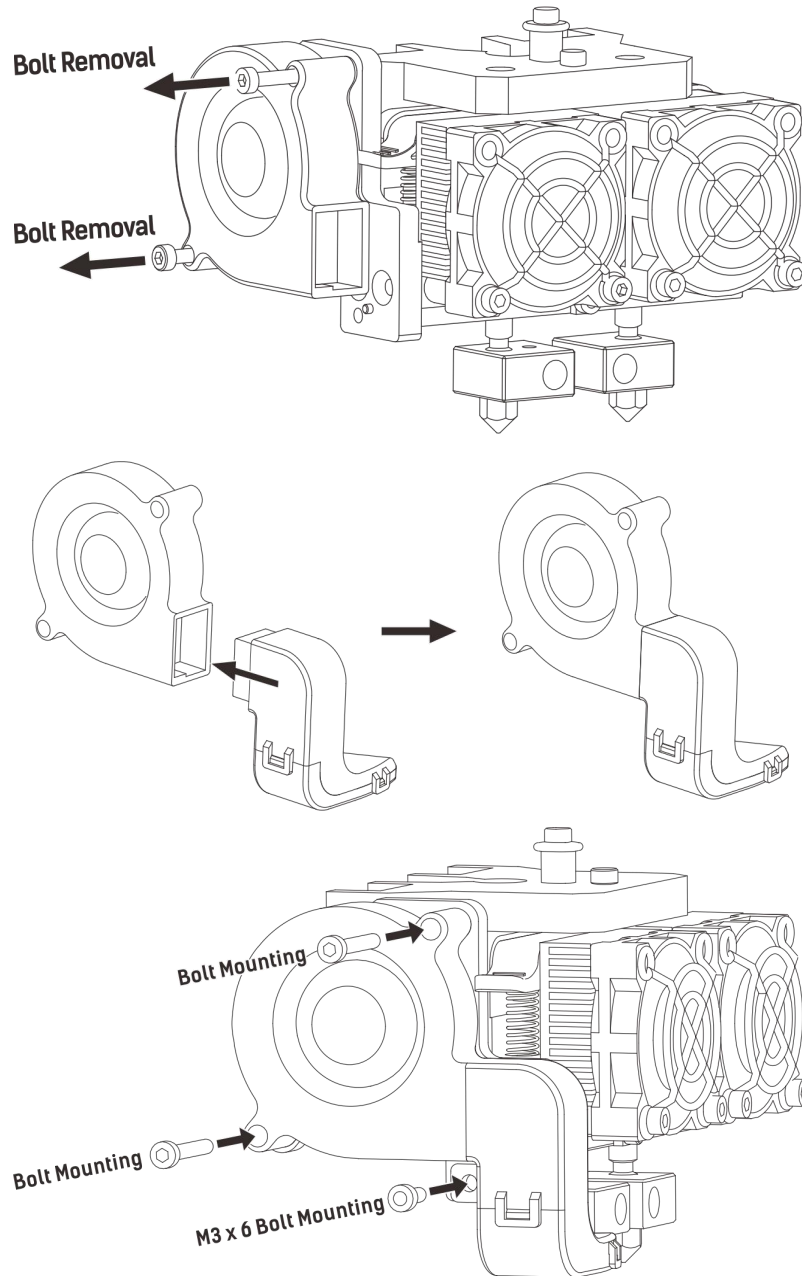

4-3

(4-3) Use the M2.5 Allen Wrench to unscrew two turbofan bolts. Take the turbofan baffle from the extruder's accessory kit. Install the turbofan baffle to the turbofan. Align the bump on the turbofan seat to the hole in turbofan sub-assembly. Place the turbofan sub-assembly besides the turbofan seat. Insert the bump on the turbofan seat to the turbofan sub-assembly. Screw the two bolts in. Take a M3 x 6 bolt from the extruder's accessory kit and complete installation.

4.2 Installing Filament

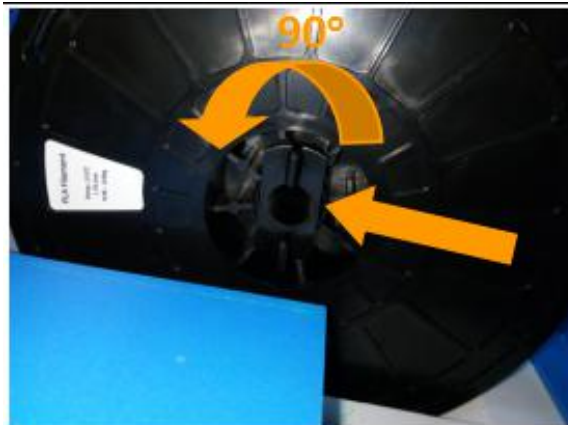

4-4

(4-4) Lock the filament in place with the filament spool holder and turn the scroll roller counter-clockwise.

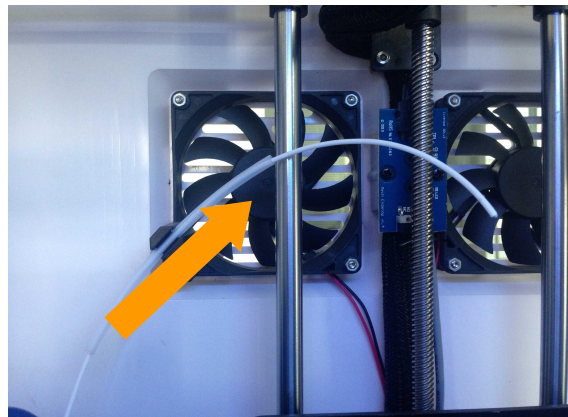

4-5

(4-5) Insert the filament through the filament guide tube. Attach the guide tube into the two filament guide tube buckles.



4-6

(4-6) Stick the build tape to the build plate after installing filament, as picture shows.

4.3 Plugging in Power Cable&USB Cable



4-7

(4-7) Locate the power cable, and plug it into the Dreamer.

Optional: Locate the USB cable and plug one end into the Dreamer and the other into your computer. The Dreamer supports USB connectivity.

4.4 Loading and Unloading Filament

Filament must be passed through the extruder and into the heating tube in order to be melted. In this user guide, we will demonstrate loading and unloading filament with the left extruder.

Loading filament:



4-8

(4-8) Remove the lid of the Dreamer

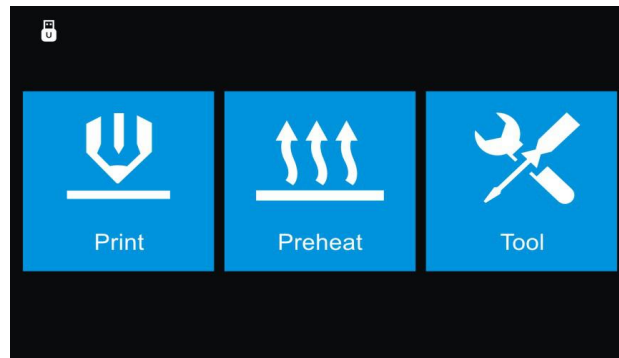

4-9

(4-9) Tap **[Tool]** in the homepage.

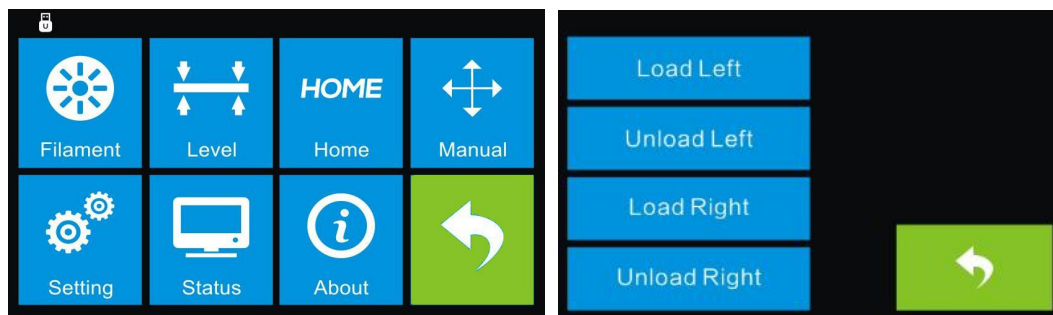

4-10

(4-10) Tap **[Filament]-[Load Left]**.

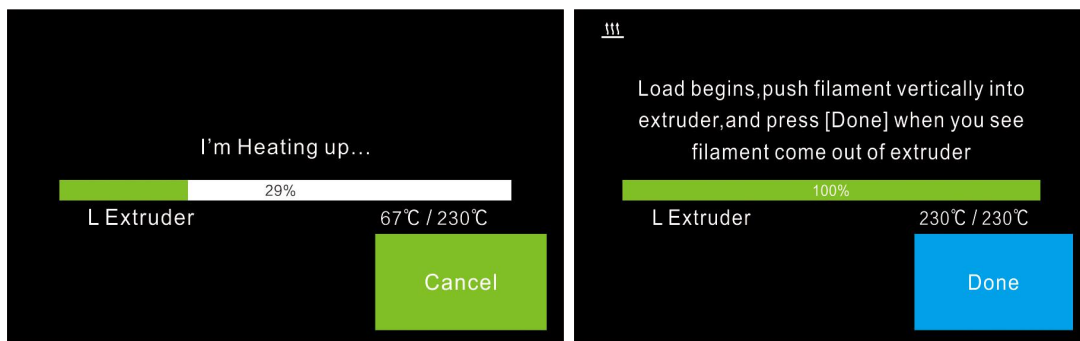

4-11

(4-11) Wait for the extruder to heat up to the operating temperature. The extruder will alert you once it is at the operating temperature. Load the filament by inserting it into the extruder at an upright angle.

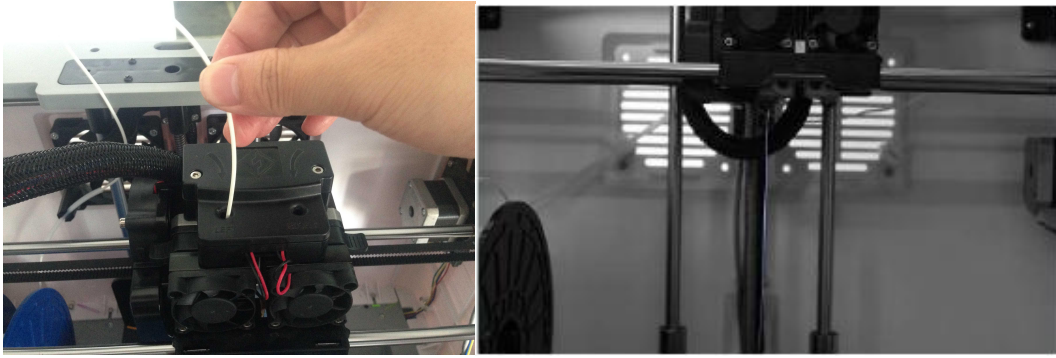

4-12

(4-12) Filament will start to be extruded out of the nozzle. Continue loading to ensure that the filament is being extruded in a straight line. Then tap **[Done]** to finish loading.

Unloading filament:



4-13

(4-13) Remove the lid of the Dreamer

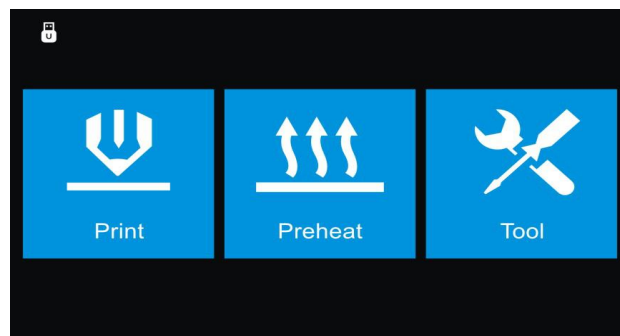

4-14

(4-14) Tap **[Tool]** in the homepage.

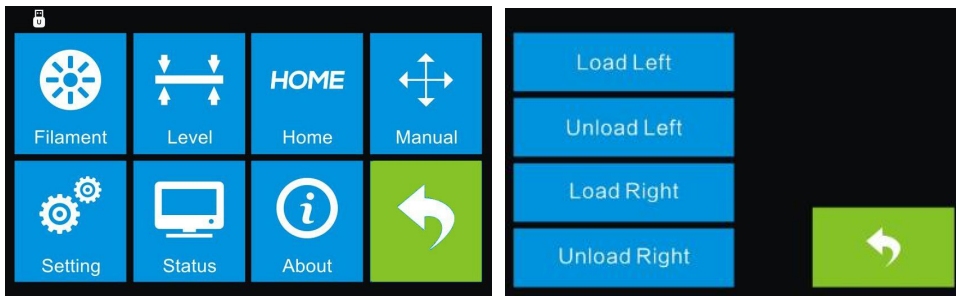

4-15

(4-15) Tap **[Filament]**-**[Unload Left]**.

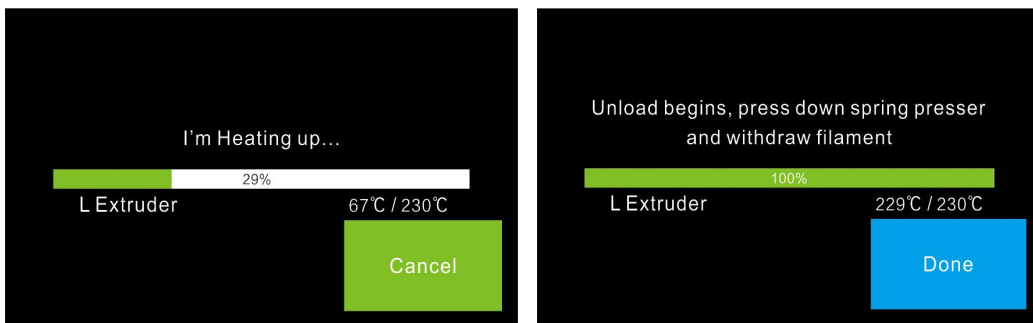

4-16

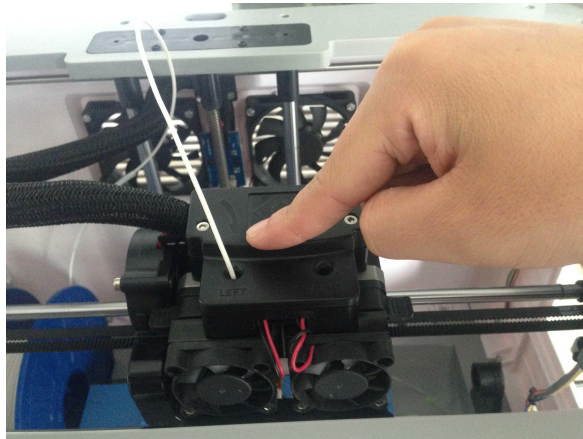

4-17

(4-16) Wait for the extruder to heat up to the operating temperature. The extruder will alert you once it is at the operating temperature. (4-17) Press the spring presser, press down the filament for about three seconds and gently pull the filament out. Then tap **[Done]** to finish unloading.

Chapter 5: Build Plate Leveling

A correctly leveled build plate is almost a guarantee for a high-quality 3D object. When there is something wrong with the printed objects, you should check whether the build plate is leveled or not firstly. A general rule of thumb is to leave a gap with the thickness of a piece of paper. However, for printing finer objects (150 micron and lower), please use a feeler gauge to level the build plate as it requires a lesser gap between the nozzle and the build plate.

The Dreamer utilizes a three-point leveling system for its build plate. At the bottom of the build plate, there is one spring-loaded knob in the front and two in the back. Tightening the screw will create a bigger gap between the build plate and the nozzle while loosening it will create lesser gap.

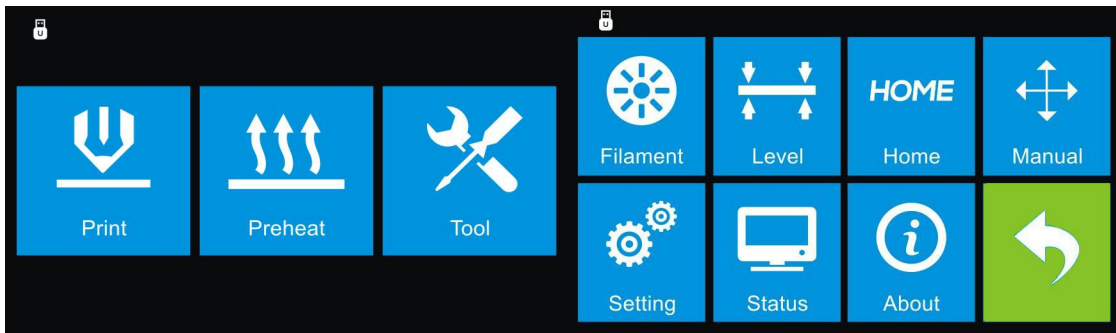

5-1

1. (5-1) From the main menu, tap **[Tool]-[Level]**. The extruder and the build plate will begin to move to the starting position.



5-2

2. (5-2) Take out the leveling card (Leveling video can be acquired by scanning the QR Code)

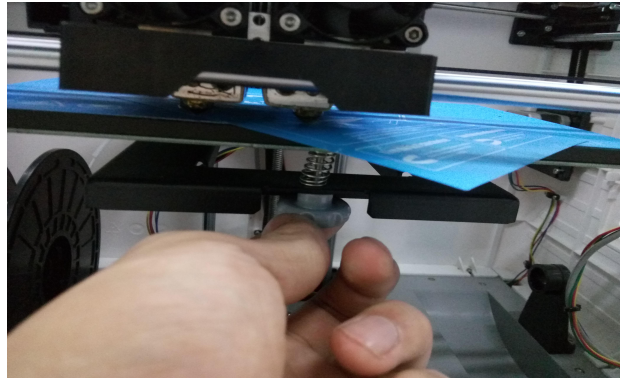

5-3

3. (5-3) Once the extruder and build plate stop moving, slide the piece of paper continuously back and forth between the nozzle and the build plate. And simultaneously adjust the knob until the paper causes a slight friction.

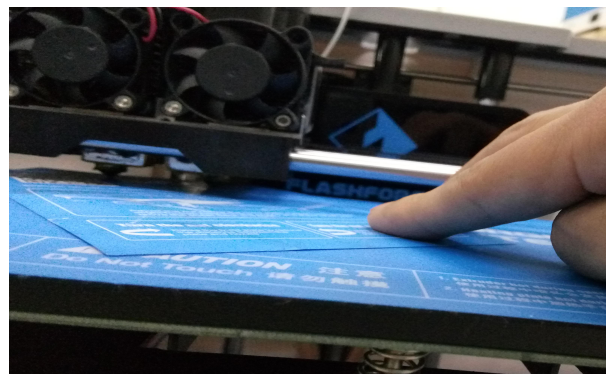

5-4

4. (5-4) Tap **[NEXT]** and wait for the extruder to move to the second position. Slide the paper back and forth again, and adjust the screw to create the same amount of friction as the previous step.

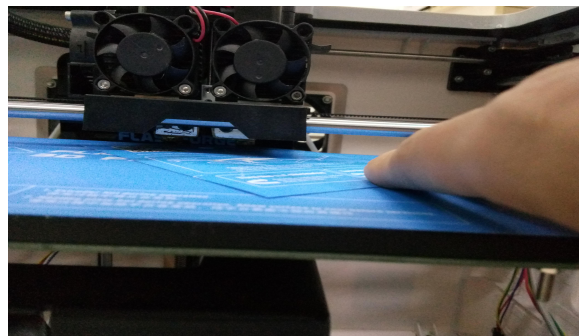

5-5

5. (5-5) Tap **[NEXT]** again and repeat the same leveling process.

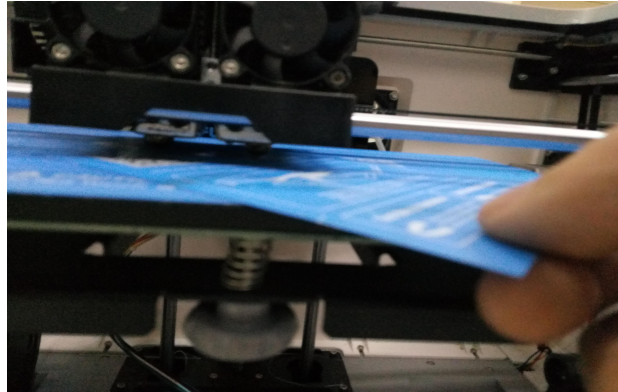

5-6

6. (5-6) Tap **[NEXT]**. The nozzle will move to the center of the build plate. Slide the paper through to make sure there is a slight friction. Slowly adjust all the screws by the same amount if there is no friction or too much friction.

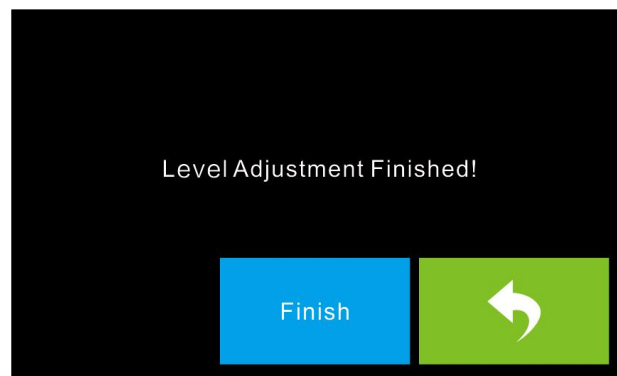

5-7

7. (5-7) Tap **[FINISH]** once you have finished this.



Chapter 6: About Software

This chapter talks about the basic function of FlashPrint. For more information about advanced function, you can browse our website <http://www.FlashForge.com>.

6.1 Software Installation

6.1.1 Software Acquisition

Method 1: To get the installation package from the SD Card in the toolkit.

 FlashPrint_3.7.1_win64	2016/1/8 8:48	Windows Install...	41,637 KB
 FlashPrint_3.7.1_win32	2016/1/8 8:48	Windows Install...	37,995 KB
 FlashPrint_3.7.1_mac	2016/1/8 8:47	压缩(zippered)文件...	16,599 KB

Method 2: Open the link below to download the installation package:

<http://www.FlashForge.com>

Support---Downloads---FlashPrint---Choose the software version---Download

6.1.2 Software Installation and Start-up

1. Decompress the zipped file or start the installation program, and then install the software according to the direction.
2. Start the software with the start menu shortcut or by clicking the software icon.(See 6-1)



6-1

6.2 Exploring FlashPrint

6.2.1 Machine Type Selection

Note! After starting FlashPrint, you need to select the target machine type first.

When you start FlashPrint, a dialog box will pop up. Just need to select FlashForge Dreamer in the machine type list and click **[OK]**. You can also change the machine type via clicking **[Print]**--**[Machine type]**. Please see graphic 6-2:

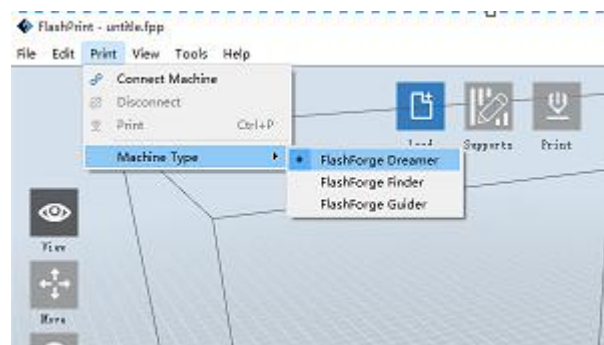





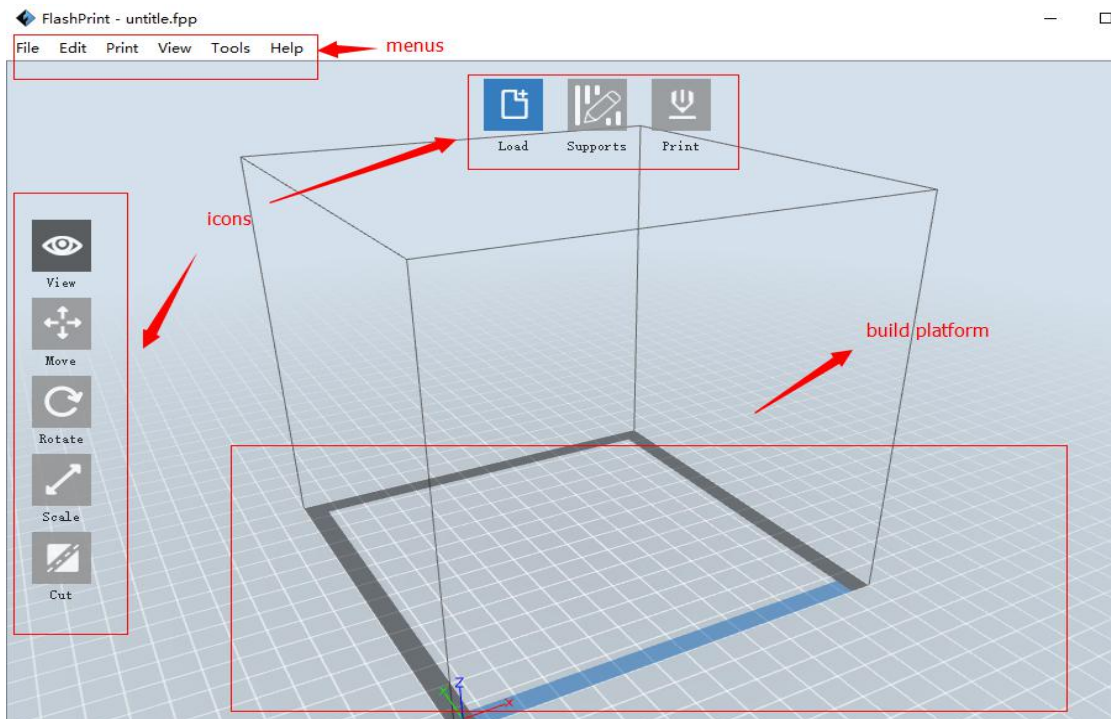



6-2

6.2.2 FlashPrint Menus



6-3

	Load files.
	Enter the support edit mode
	View FlashPrint home screen from one of six viewing angles.
	Move model around on XY-axis; shift+click to move along Z axis
	Turn and rotate your model
	Scaling the size of your object
	Cut the model into several parts
	Print it directly with your Dreamer or export to SD card.
	Select right or left extruder you want to print with.

6.2.3 Loading

You can load a model file or Gcode file into your FlashPrint by the following six methods:

Method 1: Click the **[Load]** icon on the main interface. Then select the object file.

Method 2: Select the file for loading and drag the file to the main interface of the software.

Method 3: Click **[File]**--**[Load File]**. Then select the object file for loading.

Method 4: Click [File]--[Examples] to load the example files

Method 5: Click [File]--[Recent Files] to load the files opened recently.

Method 6: Select and drag the target file to the icon of FlashPrint.

Note: .STL, .OBJ, .3MF and .FPP, ways to store 3D models, are supported by FlashPrint for editing.

Generating Rilievo

Load a png, jpg, jpeg, bmp picture file into the FlashPrint. And the following dialogue box(6-4) will pop up. The setting box includes settings for shape, mode, maximum thickness, base thickness, bottom thickness, width, height, top diameter and bottom diameter.

Shape: including plane, tube, canister and lamp.

Mode: including “darker is higher” and “lighter is higher”.

Maximum thickness: Z value of the model

Base thickness: The minimum raft thickness and the default value is 0.5mm

Width: X value of the model

Depth: Y value of the model

Bottom thickness: For tube, canister, lamp and seal to set up bottom thickness

Top diameter: For tube, canister, lamp and seal to set up the top diameter

Bottom diameter: For tube, canister, lamp and seal to set up the bottom diameter

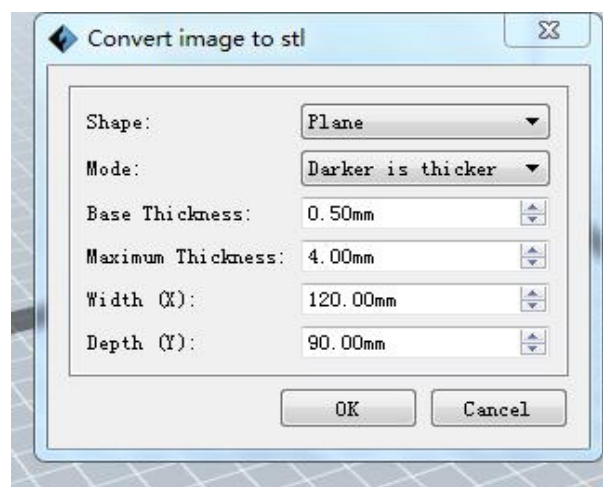

6-4



Plane 6-5

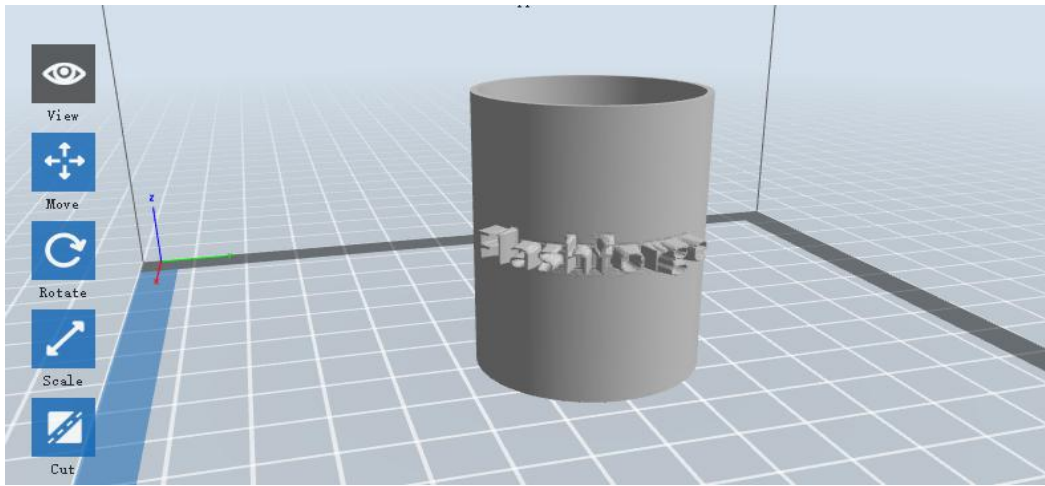

Tube 6-6

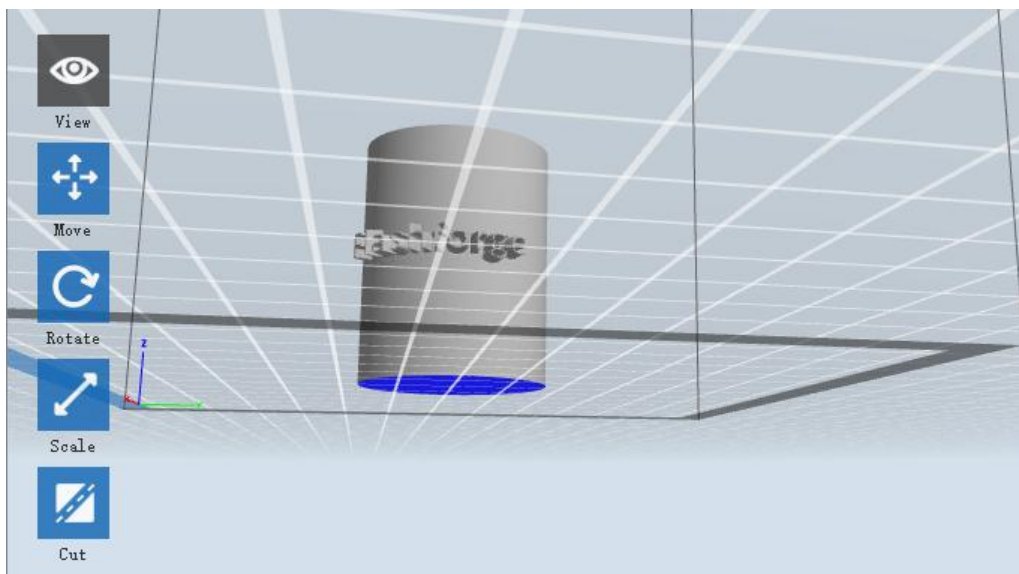

Canister 6-7

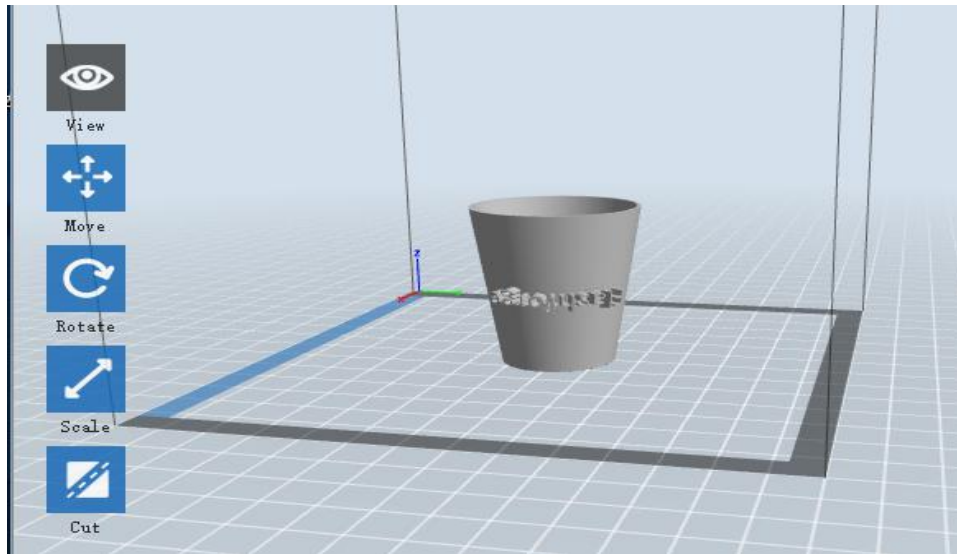

Lamp 6-8

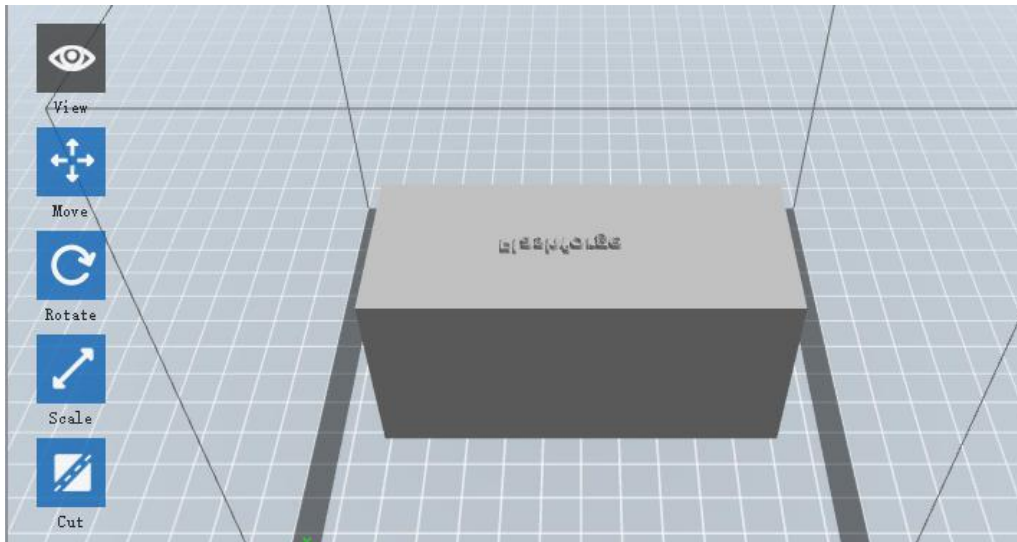

Seal 6-9

6.2.4 Views

① Changing views

Change model views by moving, rotating, scaling.

● Drag

Click the **[View]** icon and then you can move the object by the following three methods:

Method 1: Hold down the left mouse button and drag.

Method 2: Hold down the mouse wheel and scroll up and down.

Method 3: Hold down the Shift key, hold down the right mouse button and drag.

- **Rotate**

Click the **[View]** icon and then you can rotate the object by the following two methods:

Method 1. Hold down the right mouse button and drag.

Method 2. Hold down the **Shift** key, hold down the left mouse button and drag.

- **Scale**

Rotate the mouse wheel to enlarge or shrink the build plate.

② Set View

Allow users to view the object on the build plate. Six views are under the view menu, that is, bottom view, top view, front view, back view, left view and right view.

Method 1: Click the the **[View]** button, there are six views in the drop- down list

Method 2: Click the the **[Look]** icon on the left, click it again and a submenu will appear with six views for selecting.

③ Reset View

Allow users to reset views by the following two methods:

Method 1: Click the **[View]** menu and select **[Home View]**

Method 2: Click the **[View]** button on the left, click it again and you will see the viewing options, you can click **[Reset]**.

④ Show Model Outline

Click **[View]**--**[Show Model Outline]**, it will highlight the yellow border of the object

⑤ Show Steep Overhang

Click **[View]**--**[Show Steep Overhang]**. When the intersection angle between the model surface and horizontal line is within the overhang threshold value, the surface has steep overhang and it becomes red in the software. Overhang threshold value could be set as needed. The default value is 45 degree.

6.2.5 Move

Select the object and move the object by the following two methods:

Method 1: Click the **[Move]** icon on the left, Long press the left mouse button and drag to adjust the location of the model in XY direction. Long press the **Shift** key and the left mouse button, drag to adjust the location of the model in Z direction. The distance and the direction of the movement shall be displayed.

Method 2: Click the **[Move]** button on the left and then enter the distance value. Click **[Reset]** to reset distance values.

Note: Users shall click **[Center]** and **[On Platform]** after the location adjustment to ensure the model(s) be within the build area and on the build platform. If a specified position is needed, only click **[On Platform]**.

6.2.6 Rotate

Select the target object and rotate the object by the following two methods:

Method 1: Click the **[Rotate]** icon on the left and three mutually perpendicular rings appear around the object. Click one ring and rotate on the present axis, you will see the rotation angle and direction in the center of circle. In this way, you could make the model rotate on X/Y/Z axis.

Method 2: Click the **[Rotate]** icon on the left, and then enter into rotating angle values in X/Y/Z axes positioning. Click **[Reset]** to reset rotating angle values.

6.2.7 Scale

Select the target object and scale the object by the following two methods:

Method 1: Click the **[Scale]** icon on the left, hold down the left mouse button and scale the model. The corresponding values will display near the object.

Method 2: Click the **[Scale]** icon on the left and then enter into scale values in X/Y/Z axes positioning. Click the **[Maximum]** button to get largest size possible for building. Click **[Reset]** to reset the size of model.

Note: If the **[Uniform Scaling]** radio button is clicked, it will scale the model in equal proportion when changing **value** in any positioning of the model. Otherwise it will only change the value of the corresponding positioning.

6.2.8 Cut

Left-click on the model to select it and double-click on the **[Cut icon]** to set the cut plane. The direction and position are available for setting.

① Draw with Mouse

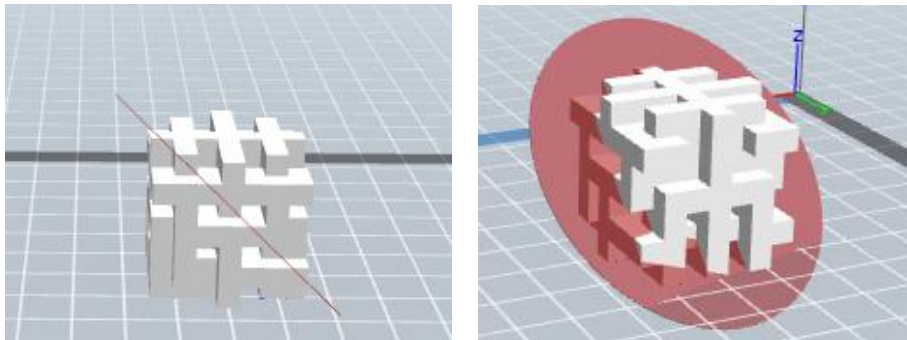

② X Plane

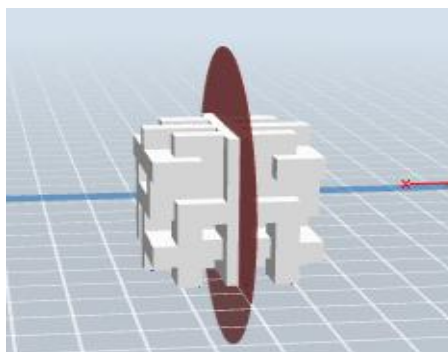

③Y Plane

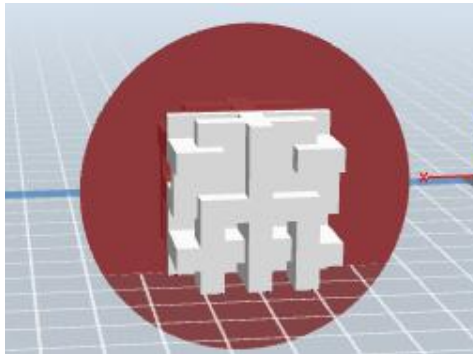

④Z Plane

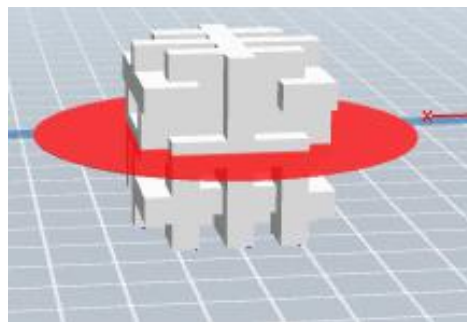

6.2.9 Extruder

(6-10) Choose L/R extruder to print, pitch on the model, click on twice, then you can set extruder .

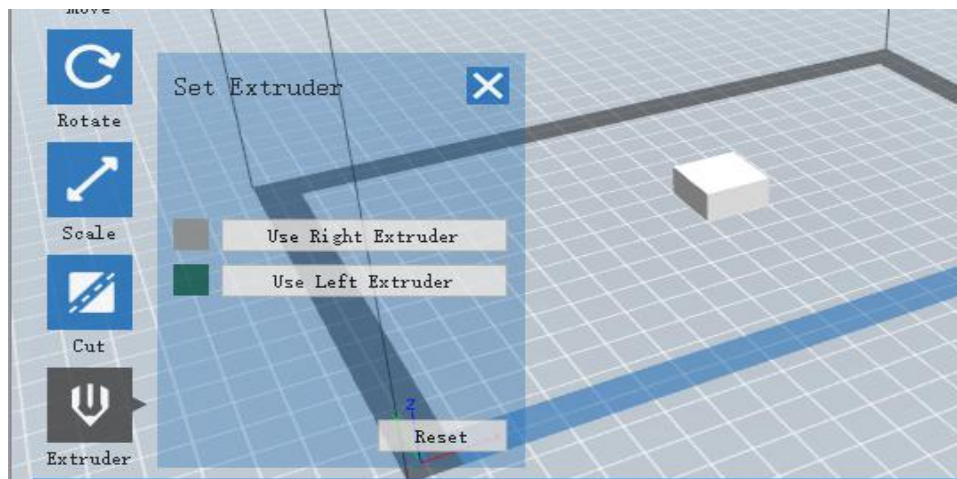

6-10

6.2.10 Supports

After loading the model, click **[Edit]--[Supports]** or click the **Supports** icon directly, then you will enter the support edit mode (6-11). Click **[Back]** to exit when you finish

editing.

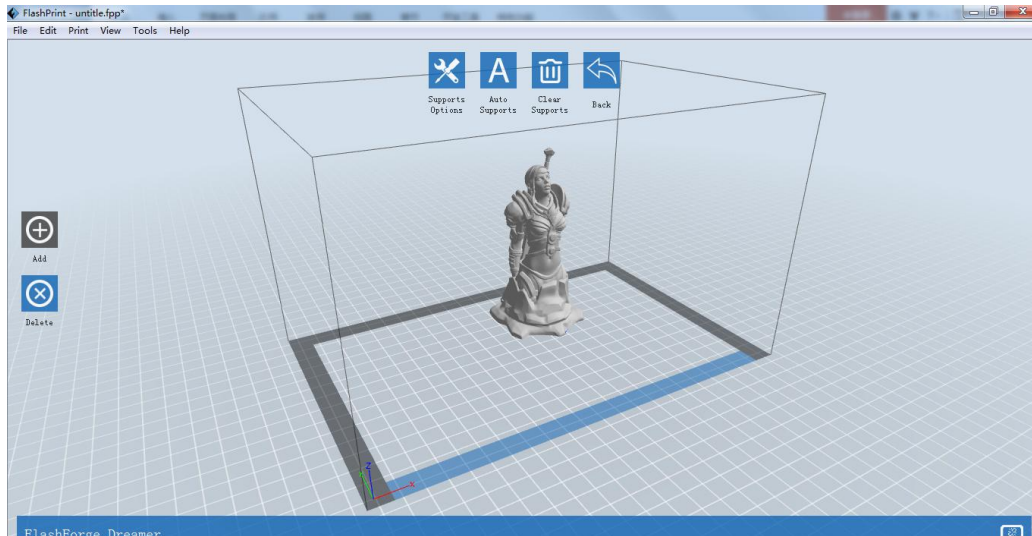

6-11

①Support Options

Click the Support Options, an option box will appear, supports options include “treelike” and “linear”, when choose “treelike”, click **[OK]**, then it will generate treelike structure; when choose “linear”, click **[OK]**, then it will generate linear structure; if it is a model with supports, when you choose one of the supports options, software will judge whether existing supports need to be deleted or not on the basis of the type of existing support, and will pop up the corresponding prompt to let you make the choice.

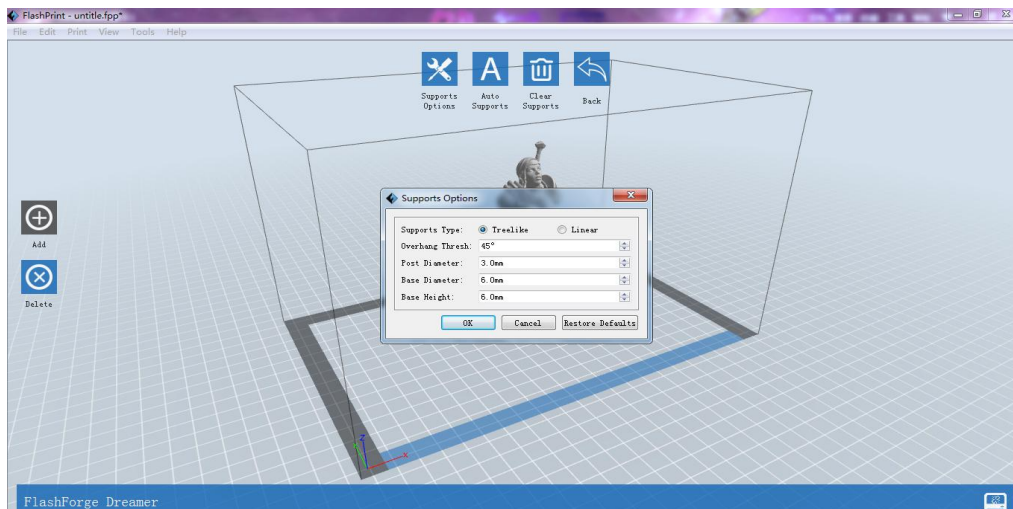

6-12

② Auto Supports

Click the **[Auto Supports]** button, the software will judge the position where supports are needed and generate corresponding treelike or linear supports. If it is a model with supports, the existing supports will be deleted and new supports will be generated.

③ Add Supports

Supports will be added once clicking the **[Add]** button. Move the cursor to the position where supports needed, left-click to choose the starting point of supports, hold down the left mouse button and drag the mouse, the supports preview will show up (if support surface doesn't need support or the support column angle is too large, the support review will be highlighted). Loosen the left mouse button, if support column doesn't meet with model, then support will be generated on origin and terminal point (the highlighted preview support won't generate support structure)

④ Clear Supports

Click **[Clear Supports]**, all supports will be deleted. The operation can be repeated via clicking **[Undo]** or pressing the shortcut key **Ctrl+Z**.

⑤ Delete Supports

Supports will be deleted once clicking the **[Delete]** button. Move the cursor to the supports needed deleting, current supports and its subnode support will be highlighted, click the left mouse button to delete these highlighted support.

6.2.11 Print

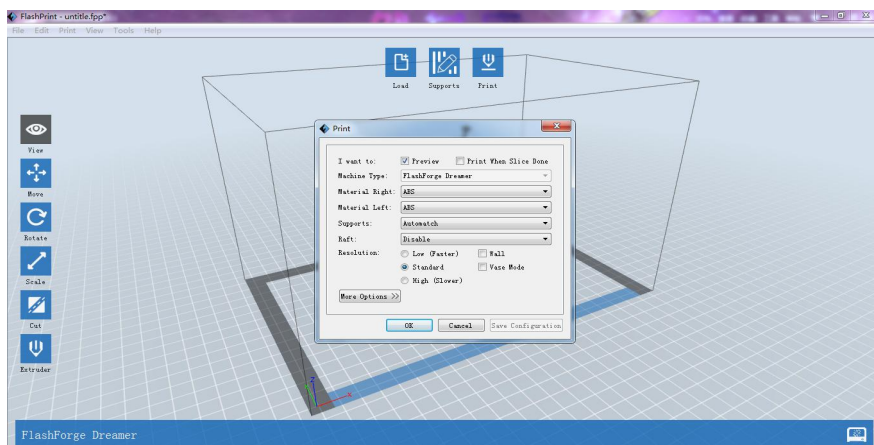

6-13

- ① **Preview:** Choose to enter preview interface or not
- ② **Print when slice done:** Print or not when slice done
- ③ **Material Right/Left:** Choose according to the type of model
- ④ **Supports:** When print suspended structure models, support is necessary. Click [\[supports\]](#) to create support part for the printing.
- ⑤ **Raft:** This function will help the model to stick well on the platform.
- ⑥ **Wall:** During dual color printing, this function will help to clear the leaking filament of another extruder.
- ⑦ **Brim:** Expand the outline of model's bottom layers to a Brim which helps anchor the edges of the model to the plate to avoid warping.
- ⑧ **Resolution :** You have three resolution solution (with default setting) to choose from, high resolution is corresponding with slow printing speed, opposite for the low resolution. For PLA printing, an extra solution "Hyper" is available.
- ⑨ **More options:** Click [\[More options\]](#) to set for layer, shell, infill, speed and temperature. Different resolution solution is corresponding to different defaults, click [\[Restore Defaults\]](#) to back to default setting.

- **Layer**

- a. **Layer:** Layer thickness of the printing model. With a small value, the surface of the model will be smoother.

- b. **First Layer Height:** This is the first layer of the model, which will affect the sticking performance between the model and platform. Maximum is 0.4mm, usually the default is OK.

- c. **Shell:** Contains the outside shell value, capping layer value (under vase pattern, top solid layer setting is invalid.)

- **Perimeter Shells:** Maximum is 10

a. Top Solid Layer: Maximum is 30, minimum is 1.

b. Bottom Solid Layer: Maximum is 30, minimum is 1.

- **Infill**

a. Fill Density means fill rate.

b. Fill Pattern is the pattern of filling shape which effects printing duration.

c. Combine Infill: You can select the layers for combining according to the layer thickness. The combined thickness should not exceed 0.4mm. “Every N layers” is for all the infills while “Every N inner layers” is only for inner infills, which generally can save print time.

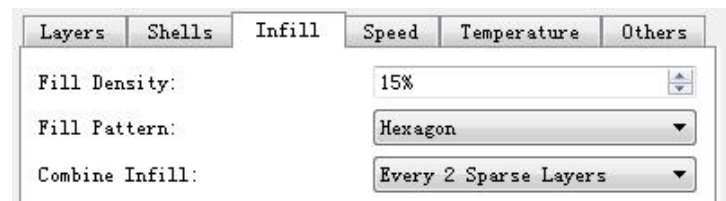

6-14

- **Speed**

a. Print Speed is the moving speed of the extruder. Generally, the lower speed is, the better print you will get. For PLA printing, 60 is recommended.

b. Travel Speed is to control the moving speed of the extruder under non-printing status during work. For PLA printing, 80 is recommended.

Note: Modify parameters settings to get better prints as different models need different parameters.

- **Temperature**

Right Extruder Temperature: Recommended extruder temperature is 220°C.

Note: Different temperatures have subtle influences in printing. Please adjust the temperature according to the condition in order to get a good print.

Platform Temperature: To set the temperature of Platform.

- **Others**

Cooling Fan Control: Set up the time to turn on the cooling fan. You can pre-set the height and make the cooling fan begin to work at the point.

Pause At Heights: Allow users to pre-set a height in which the print will suspend automatically. The function usually applied when you want to change the filament at a certain point.

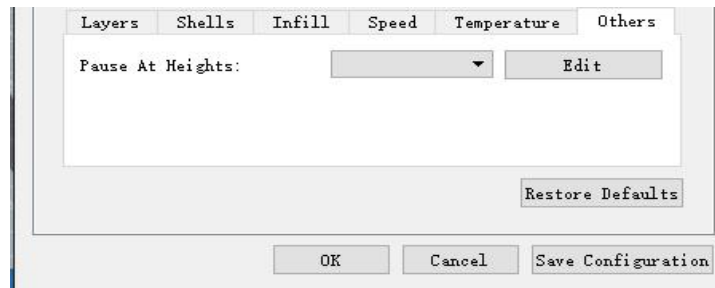

6-15

6.2.12 File Menus

① New Project

Click **[File]**--**[New Project]** can build a blank project. If there is an unsaved modification on previous project, then it will inform you whether the modification needs to be saved or not. Click **[Yes]** will save the modification; click **[No]** will abandon it. If click **[Cancel]** or close tool tip, then it will cancel the new project.

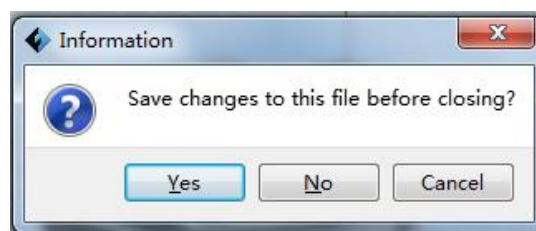

6-16

② Saving

After finishing the model edit and adjustment, there are two ways below to save all models in the scene.

Method 1:

Click **[File]--[Save Project]** in the menu bar to save the file as a project file with the “.fpp” suffix, all models in the scene (include support) are independent. After reloading the files, extruder configuration information and model position will be the same as the configuration during saving.

Method 2:

Click on **[File]--[Save as...]** to save the model as project file .fpp or .stl and .obj. For .stl and .obj, models are integrated as one (include support part). If load it again, only the position of the model was saved, not included the printing parameters.

③ Preferences

Click **[File]--[Preferences]**, you can choose language and if needs detecting update when start.

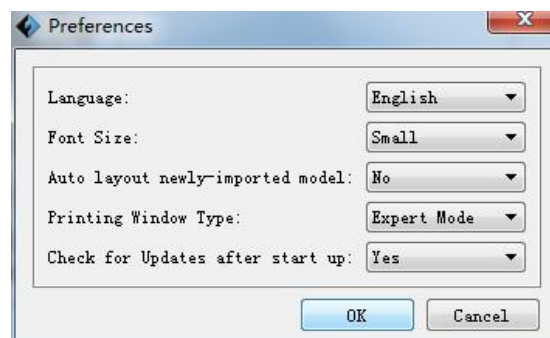

6-17

- **Language:** The software supports several languages, namely, Chinese (simplified Chinese and traditional Chinese), English, French, Korean, Japanese and so on.
- **Font Size:** Set the font size.
- **Auto layout newly-imported model:** Set Yes or No.
- **Printing Window Type:** Including Base Mode and Expert Mode.
- **Check for Update after start up:** It is used to preset if it is necessary to activate the online automatic update function, if choose yes, every time when you open software, it can online detect if it is a new version software, once new version found,

it will remind users to download and install the new version of the firmware.

6.2.13 Edit Menus

① Undo

Allows users to undo the recent edits by the following two methods:

Method 1: Click **[Edit]--[Undo]**.

Method 2: Press the shortcut **Ctrl+Z**.

② Redo

Allows users to redo the most recent edit you have undone to your model file by the following two methods

Method 1: Click **[Edit]--[Redo]**

Method 2: Press the shortcut **Ctrl+Y**.

③ Empty Undo-stack

To clean up the recorded operating steps so as to release the memory.

④ Select All

By the following two methods, you could select all models in the scene.(When models are too small to be seen or out of viewing scope, please click **[Center]** and **[Scale]** buttons to adjust the model.)

Method 1: Click **[Edit]--[Select All]**.

Method 2: Press the shortcut **Ctrl+A**.

⑤ Duplicate

Select the object and duplicate the object through the following two methods:

Method 1: Click **[Edit]--[Duplicate]**

Method 2: Press the shortcut **Ctrl+D**

⑥ Delete

Select the object and delete the object through the following two methods:

Method 1: Click **[Edit]--[Delete]**

Method 2: Press the shortcut **Delete**

⑦ Auto Layout All

Click **[Edit]--[Auto Layout All]** after loading one or more than one models, all models will be placed automatically as automatic placement rule.

⑧ Repair Models

Click **[Edit]--[Repair Models]** to repair models.

⑨ Supports

Click **[Edit]--[Supports]** to enter supports setting interface.

6.2.14 Print Menus

① Connect Machine

You can connect the Dreamer with your PC via a USB cable or WiFi.

Note: The machine icon on the bottom right displays the connection status:

Connected



Disconnected



Method 1: Connect Via USB Cable

- a. Connect your Dreamer with your PC via an USB cable.
- b. Turn on your Dreamer and start FlashPrint.
- c. Click **[Print]--[Connect Machine]**, then select USB in the **[Connection Mode]** option and select machine you want to connect in **[Select Machine]** option. If you can not find your machine, click the **[Rescan]** button to scan your machine and select it. Finally click **[Connect]** button to connect to the printer. If you still can not find your machine after rescan, it means you haven't installed the driver in the software.

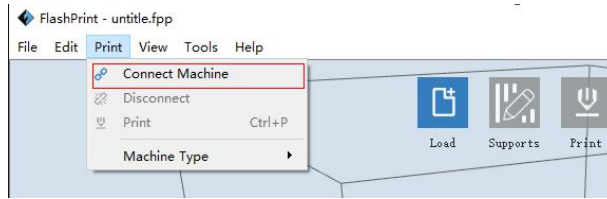

6-19

Method 2: Connect Via WiFi

1. Turn on Dreamer.
2. Turn on Wi-Fi on the Dreamer. Tap **[Tools]-[Setting]-[WiFi]-[WiFi ON]**.
3. A connection called **“USR-WiFi232-G2”** can be found on the list of available networks. Connect to this network.
4. Open your Internet browser. Type in **“10.10.100.254”** and hit **[Enter]** on your keyboard. Enter the username and password to login. The default username and password are both **“admin”** The control panel will appear after a successful login.



6-21

5. Click on **[Work Mode]** and choose **“AP+STA mode”** and save it.

!Notice: In STA mode, there may be the risk that Dreamer couldn't be connected via WiFi forever, if STA mode is set in error.

6. Click on **[STA Setting]**, select a working network, enter the corresponding password and save.



6-22

7. Restart the interface, close the page, turn off the Dreamer, disconnect from the network, and wait for 10 seconds.

8. Turn on the Dreamer again and connect your computer to the network named **“USR-WiFi232-G2”**, launched by Dreamer. Click **[Print]-[Connect]** in FlashPrint.

9. Under **“Connection Mode”**, select Wi-Fi, and enter the **“IP Address”** as shown on printer touch screen. Then, click **[Connect]**.

10. If successfully connected, you will see the following red mark.



Disconnect Dreamer

Click **[Print]--[Disconnect]** to disconnect your PC and Dreamer.

6.2.14 Tool Menus

①Control Panel

After connecting PC with Dreamer, click **[Tools]--[Control Panel]** to open the control panel.

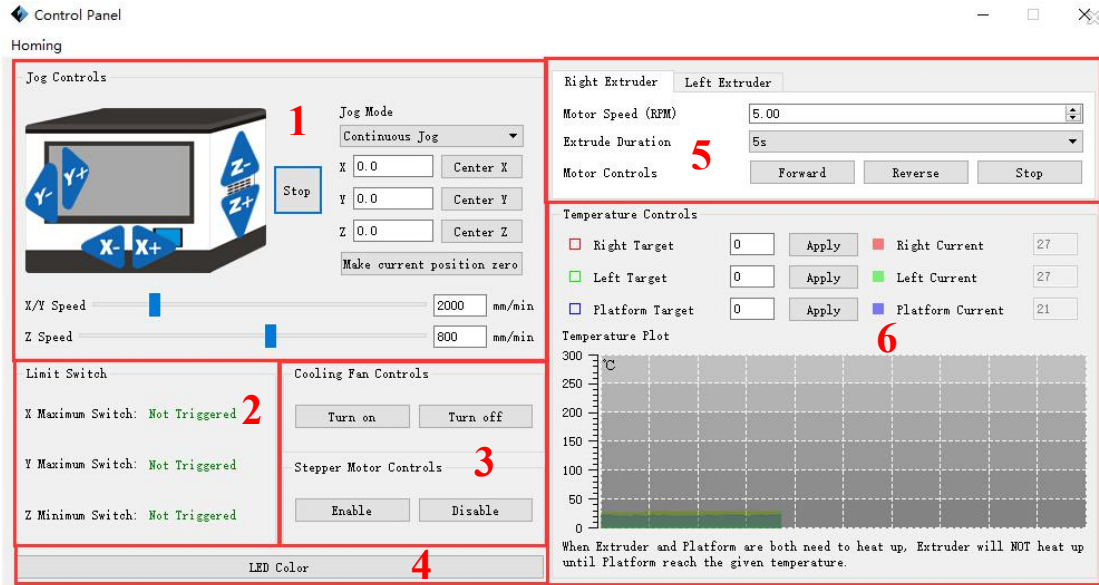

• Jog Controls

a. Jog Mode: Select the distance that extruder/build plate move a single time (that is, the distance extruder/build plate move upon your single click).

b. Six blue arrow direction buttons: Control the move along X/Y/Z axis. X/Y axis button control extruder move, Z axis button control build plate move. Click X-, extruder will move leftward a specified distance; Click X+, extruder will move a specified distance rightward. Click Y-, extruder will move forward a specified distance; Click Y+, extruder will move backward a specified distance. Click Z-, build plate will move upward a specified distance; Click Z+, build plate will move downward a specified distance. (Specified distance refers to the move distance you set in Jog Mode).

c. Stop: Click the **[Stop]** button to abort the current movement.

d. XYZ coordinate frame on the right side: Show the current position of extruder/build plate.

e. Make Current Position Zero button: Set the current position of the extruder/build plate as (0, 0, 0). (**NOTE:** X, Y, and Z boxes are for display purposes. Changing the value in the boxes will not affect anything).

f. Center X/Y/Z button: Extruder and build platform will back to the zero (0, 0, 0) you set last time.

g. X/Y Speed and Z Speed: Set the move speed of extruder/ build platform.

● **Limit Switch:** In order to protect your Dreamer, three limit switches are equipped to control the maximum position, and the three limit switches corresponding to X/Y/Z axis limit switch. It has two statuses:

a. Not Triggered: If the extruder/build plate don't move to its maximum, X/Y/Z axis limit switch is not triggered, and shows “**Not Triggered**”.

b. Triggered: If the extruder/build plate moves to its maximum, X/Y/Z axis limit switch is triggered, and shows “**Triggered**”.

● **Stepper Motor Controls:** Allows users to control to stepper motor. Click [\[Enable\]](#), and lock the motor so it does not allow any movement; click [\[Disable\]](#), and unlock the motor to be controlled manually.

● **LED Color:** Allows users to change the LED color of Dreamer.

● **Extruder Controls:** You can set the value of “[Motor Speed \(RPM\)](#)”, which can control the rotation speed of filament feeding wheel. The motor rotation time can be controlled via setting the value of “[Extruder Duration](#)”. Generally we suggest the users choose option of continuous time 60 seconds. The filament must be loaded in the extruder before motor starts. **Therefore, do not start rotation operation until the extruder temperature reach the printing temperature of filament.** For PLA filament, the extruder temperature should reach 220°C, after reaching the extruder temperature, click the [\[Forward\]/\[Reverse\]](#) rotation button to control filament load and filament unload. Furthermore, if you want to stop filament load and unload, you can click [\[Stop\]](#).

● **Temperature Control:** Input the temperature you want to get in the left frame, click [\[Apply\]](#), the printer will automatically heat the corresponding part, the right side

shows the current actual temperature of corresponding part. After start heating, the below curve of temperature form will start to change, different color correspond with different parts' temperatures

② Update Firmware

Every time when you start FlashPrint, it will automatically detect and download the up-to-date firmware. If any update is available, a dialog box will pop up for reminding the users to update.

Step 1: Click **[Tools]--[Update firmware]**. It needs to cut off connection before updating firmware. If software and printer are already in connection, it will remind you cutting off the connection. Then choose **[Yes]** and go on to the next step.

Step 2: Choose corresponding printer type and firmware version and click **[OK]** in the firmware updating box. After confirming the printer is in free state, the software will automatically update the firmware.

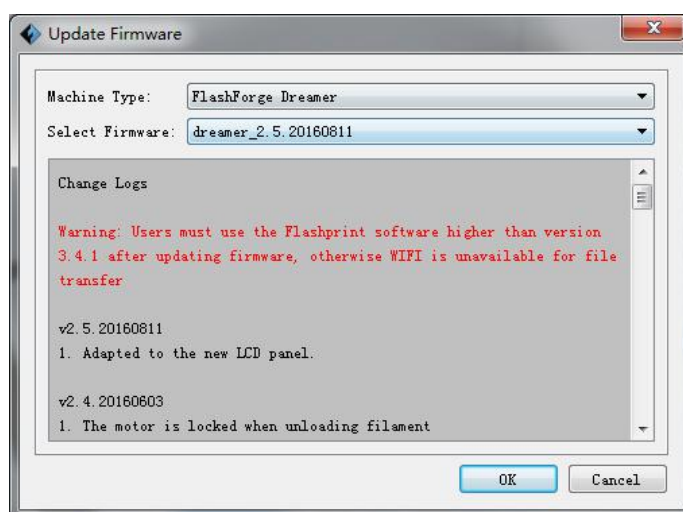

6-23

Step 3: Reboot you Dreamer and wait for 4-5 seconds, then you can see the update process bar. When the update finishes, it will go back to the main interface.

Step 4: Tap **[Tools]--[About]** to check whether the updated version is right.

③ On Board Preferences

When the computer and printer are in connection, click [\[Tools\]--\[On Board Preferences\]](#), you can check the printer name.

④ Machine information

When the computer and printer are in connection state, click [\[Tools\]--\[Machine information\]](#), you can check the machine type, machine name and firmware etc.

6.2.15 Help Menus

① First Run Wizard

② **Help Contents:** Click [\[Help\]--\[Help Contents\]](#), you can read the help contents.

③ **Check for Updates :** Click [\[Help\]--\[Check for Update\]](#) to detect the available updates online.

④ **About FlashPrint:** Click [\[Help\]--\[About FlashPrint\]](#), the software information box will pop up. The contents include the current software version and copyright information.

Chapter 7: Basic Printing

This chapter will provide a step-by-step guide on turning a 3D model into a physical reality. Before proceeding, it is recommended that you go over prior chapters on loading/unloading filament, leveling the build plate, and the functions and capabilities of FlashPrint.

There are two modes of printing: single-extrusion and dual-extrusion. With single extrusion, you can choose the print head to use for making the print. Dual extrusion is useful if you want to print dual colors or complex models that require supporting material.

There are three connection methods in order to print using the Dreamer. All methods, which include USB, SD card, and Wi-Fi are covered in this chapter.

7.1 Single-Extrusion and Dual-Extrusion Print

7.1.1 Single-Extrusion Print

1. Open **FlashPrint** by double-clicking on the icon.
2. Click on **[Load]** and choose a .stl file from hard drive.
3. The object will then be shown on the screen.
4. Click on the object and then click on **[Extruder]**, select **[Use left extruder]**.
*Left extruder will be used for illustration purposes.
5. Now the 3D model is ready to be created.

7.1.2 Dual-Extrusion Print

1. Open **FlashPrint** by double-clicking on the icon.

2. Click **[Load]** and choose a .stl file from hard drive.
3. The object will then be shown on the screen.
4. Click **[Load]** and choose another (or the same) file from hard drive.
5. Click on the object and then click on **[Extruder]**, select **[Use left extruder]**.

NOTE: one object is turned to green, that indicates it will be print wit the left extruder.

6. Now the 3D model is ready to be created.

Before introducing the connection methods, let me give you a brief introduction of Dreamer’s interfaces.

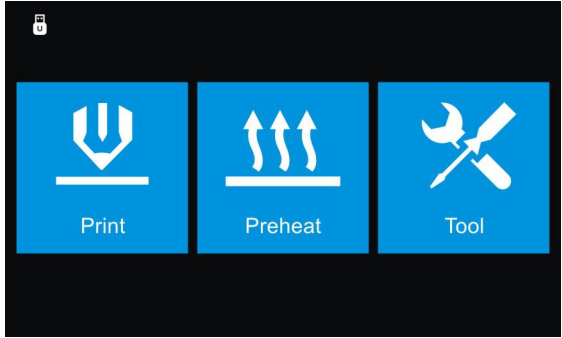
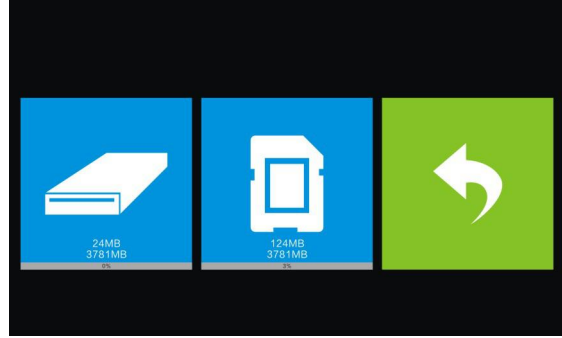

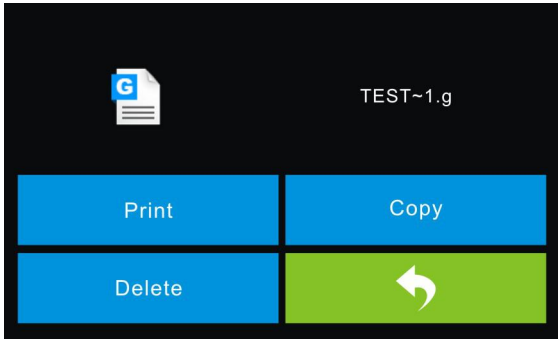
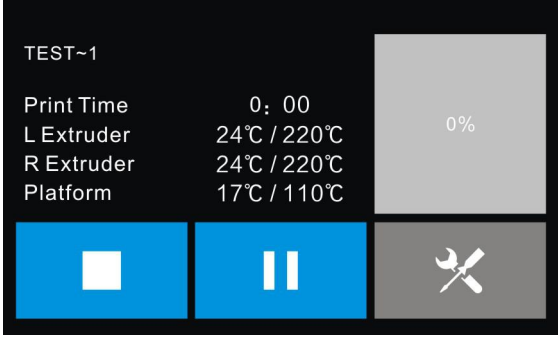
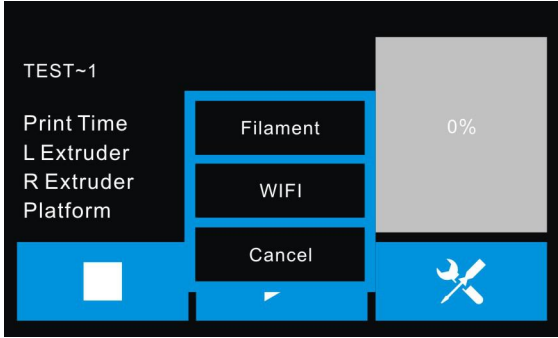
	<p>Print</p>
	<p>Read the print file from</p> <ul style="list-style-type: none"> The local memory card The SD card Back

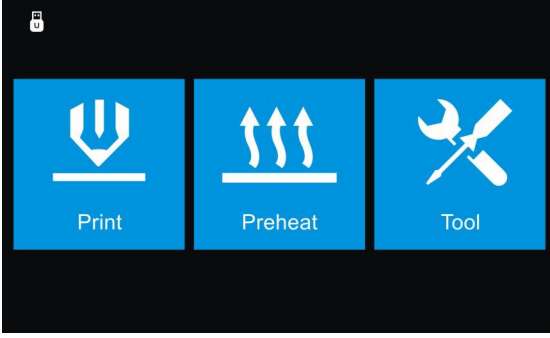
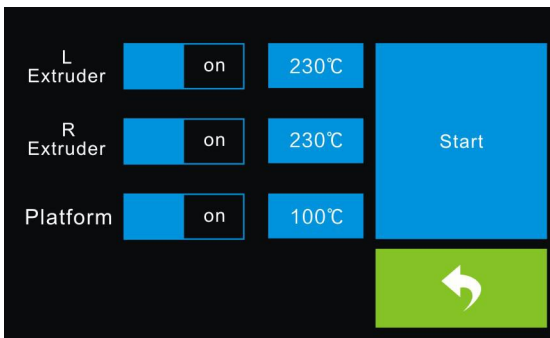
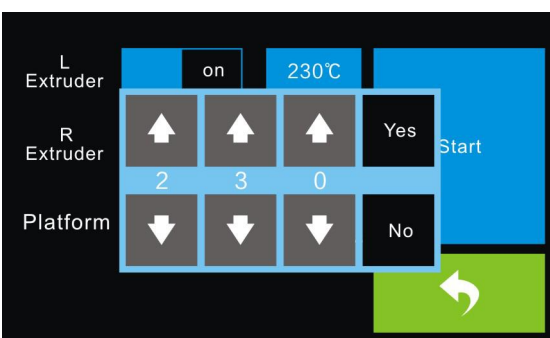
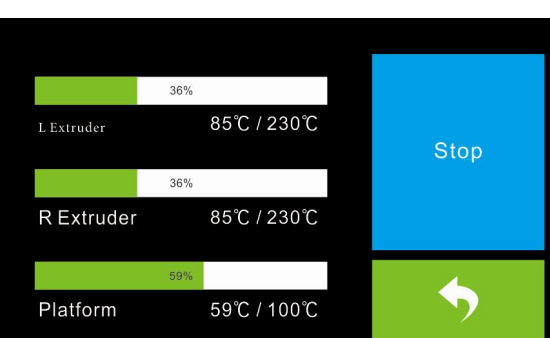
	<p>Select the target print file among the list</p> <p>Print: To begin printing</p> <p>Copy: To copy the files to the local memory card from the SD card.(No available [Copy] button for printing from local memory card)</p> <p>Delete: To delete the print file</p> <p>Back</p>
	<p>Print interface</p> <p>Abort: To abort the printing job.</p> <p>Pause/Resume: To suspend or resume the print job.</p> <p>Tools: To change filament and set up auto shutdown during printing.</p>
	<p>Tools in print interface</p> <p>Filament: To change filament during printing. (Note: You need to suspend the operation first)</p> <p>WiFi: To turn on the WiFi</p> <p>Cancel: To end the tool orders and return to the print interface.</p>

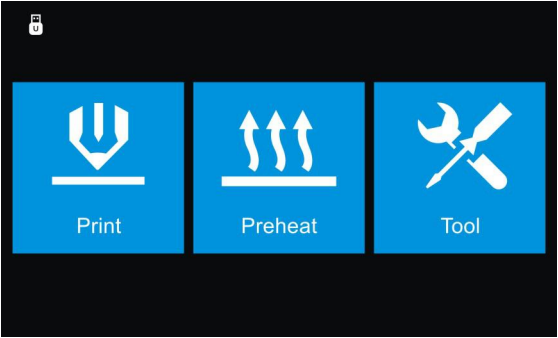
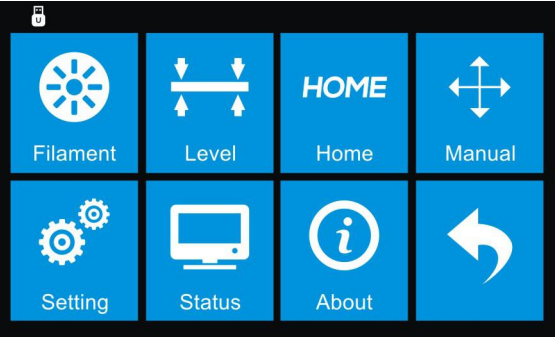
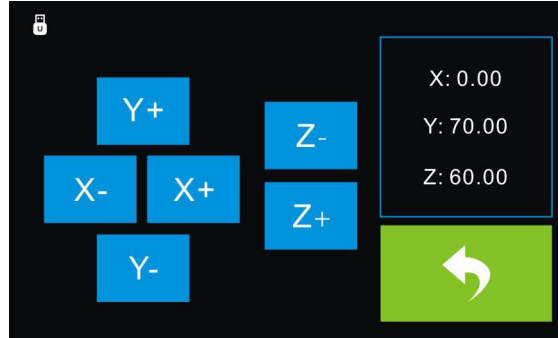
 <p>The image shows a main menu with three blue buttons: 'Print' with a printer icon, 'Preheat' with three upward arrows, and 'Tool' with a wrench and screwdriver icon.</p>	<p>Preheat</p>
 <p>The image shows the preheat interface with three rows: 'L Extruder' (on, 230°C), 'R Extruder' (on, 230°C), and 'Platform' (on, 100°C). A 'Start' button is on the right, and a green back arrow is at the bottom right.</p>	<p>Tap the [Preheat] button to enter the preheat interface. Tap the [Start] button to heat up to the setting temperature. The default temperature is 230°C. Tap the temperature display bar to set the temperature.</p>
 <p>The image shows a keypad overlay for temperature adjustment. It has three rows: 'L Extruder' (on, 230°C), 'R Extruder' (up arrows, Yes), and 'Platform' (down arrows, No). The keypad also shows numbers 2, 3, and 0. A 'Start' button is on the right, and a green back arrow is at the bottom right.</p>	<p>To set the preheat temperature. Tap [Yes] to save the setting while tap [No] to cancel the setting.</p>
 <p>The image shows the preheat progress interface. It has three rows: 'L Extruder' (36% progress, 85°C / 230°C), 'R Extruder' (36% progress, 85°C / 230°C), and 'Platform' (59% progress, 59°C / 100°C). A 'Stop' button is on the right, and a green back arrow is at the bottom right.</p>	<p>The picture displays the preheat interface. It shows the actual temperature and the target temperature. Tap the [Stop] button to abort the preheat job.</p>

	<p>Tool</p>
	<p>Tap [Tool] to enter tool options.</p> <p>Filament: To load/unload the filament.</p> <p>Level: To adjust the build plate.</p> <p>Home: To make the X, Y and Z axes back to the zero point.</p> <p>Manual: To manually adjust the positions of X, Y and Z axes.</p> <p>Setting: To implement relevant function setups.</p> <p>Status: To check the real-time status of the printer.</p> <p>About: Information about the printer.</p> <p>Back</p>
	<p>Manual adjustment</p> <p>Y+: The extruder moves to the zero point, that is, the back of the machine</p> <p>Y-: The extruder moves to the direction opposite to the Y+.</p> <p>X+: The extruder moves to the zero points, that is, to the right direction</p> <p>X-: The extruder moves to the direction opposite to the X+.</p> <p>Z+: The build plate elevates.</p> <p>Z-: The build plate descends.</p> <p>Back</p>

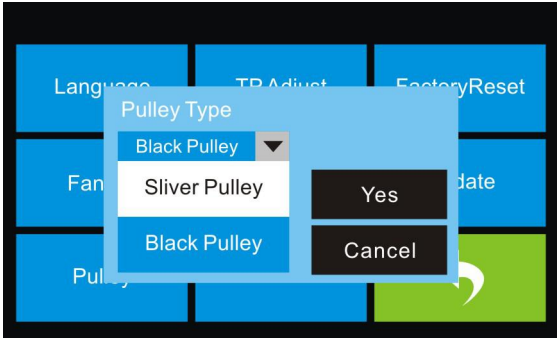
	<p>Tap [Setting] to enter the setting interface</p> <p>Language: To set the display language TP Adjust: Adjust the touch screen Factory Reset: Restore factory defaults Fan on: To turn on/off the fan WiFi: To turn on/off the WiFi Update: To update the firmware Pulley: To choose the pulley type Enable filament detector: To enable or disable filament detector.</p> <p>Back</p>
	<p>Language:</p> <p>User can select corresponding language as required.</p>
	<p>TP Adjust:</p> <p>To tap the “+” on the touch screen to adjust the touch screen.</p>
	<p>WiFi:</p> <p>Turn on the WiFi: Turn on the WiFi, release the WiFi hotspot and set the WiFi on computer</p> <p>Backg</p>

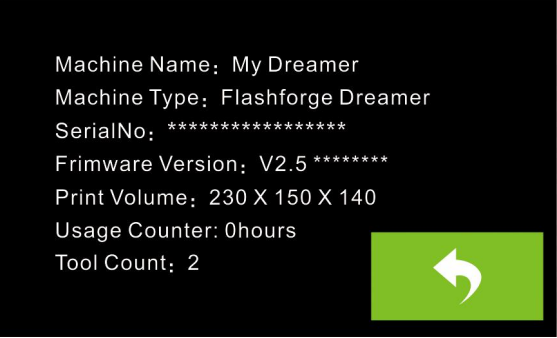
	<p>Pulley:</p> <p>To select the equipped pulley type.</p>
	<p>Status:</p> <p>It displays the real-time status of the extruder temperature, the platform temperature and the internal temperature.</p>
	<p>About:</p> <p>It displays the basic information about the device.</p>

7.2 Methods of printing

Printing from USB

1. Connect Dreamer to the computer with the USB 2.0 cable.
2. Turn on the Dreamer. Make sure the build plate is leveled and filament is loaded into the left extruder.
3. Select **[Print]** from menu bar, then select **[Connect]**.
4. Click on **[Rescan]**, then **[Connect]**.

5. Now the printer is connected with FlashPrint. A status box at the lower right corner will show the temperature of both extruders and the platform.
6. Click **[Print]** icon, and a printing options screen will appear. Make sure that **“ABS”** is selected under **Material Left**. Advanced settings can be set under **[More Options]** . Check the box **“Print When Slice Done”** and click **[OK]**.
7. Save the file at any location, and the object will start slicing
8. After slicing the object, it will automatically upload the gcode to the Dreamer.
9. After the gcode is done uploading, the printer will go preheating. The Dreamer will begin printing once it has finished preheating.

Printing from SD Card

1. Click **[Print]**, and a printing options screen will show up.
2. Make sure that the **“Material Left”** is selected as **“ABS.”** Advanced settings can be set under **[More Options]** icon.
3. Click **[OK]**, and save the gcode file in the SD card.
4. FlashPrint will begin slicing the 3D model.
5. After slicing the object, take the SD card out from the computer. Insert it into the SD card slot onto the Dreamer.
6. Turn on the Dreamer. Make sure the build plate is leveled and filament is loaded on the left extruder.
7. Tap **[Print]** and then tap the middle **SD Card** icon.
8. A list of file(s) will show up, tap the file that you would like to print, and tap **[Yes]**.
9. The printer will now enter preheating and will start printing once it finishes preheating

Printing via Wi-Fi

1. Turn on Dreamer. Make sure the build plate is leveled and filament is loaded on the left extruder
2. Turn on Wi-Fi on the Dreamer. Then tap **[Tool]-[Setting]-[WiFi]-[WiFi ON]**.

3. A connection called “**USR-WiFi232-G2**” can be found on the list of available networks. Connect to this network.

4. Open your Internet browser. Type in “**10.10.100.254**” and hit **[Enter]** on your keyboard. Enter the username and password to login. The default *username* and *password* are both “**admin**”. The control panel will appear after a successful login.



7-2

5. Click on **[Work Mode]** and choose “**AP+STA mode**” and save it.

Notice: In STA mode, there may be the risk that Dreamer couldn't be connected via WiFi forever, if STA mode is set in error.

6. Click on **[STA Setting]**, select a working network, enter the corresponding password and save.



7-3

7. Under “**Connection Mode**”, select Wi-Fi, and enter the “**IP Address**” as shown on printer touch screen. Then, click [**Connect**].
8. Now the Dreamer is connected with FlashPrint. A status box at the lower right corner will show the temperature of both extruders and the Platform.
9. In FlashPrint, click [**Print**]. A printing options screen will appear. Make sure that “**ABS**” is selected under “**Material Left**.” Advanced settings can be set by clicking on [**More Options**]. Check the box of “**Print When Slice Done**”, and click [**OK**].
10. Save the file at any location, and the object will start slicing. After the object is done slicing, it will automatically upload the gcode to the Dreamer. After the gcode is done uploading, the printer will go into a preheat phase. The Dreamer will start printing once preheating is finished.

NOTE: Printing from SD card is unavailable when WiFi is ON.

Printing with Support

If the 3D model has excessive over-hang, then support will be needed. In the **Slice** options screen, select from “**Supports**” the left or right extruder. Click [**OK**] to begin slicing.

Chapter 8: Supports and Service

FlashForge team is on standby and ready to help you overcome any challenges you may have with your Dreamer. If the issues or questions are not covered in this User Guide, you can seek for solutions on our official website or contact us via telephone.

There are solutions and instructions to common issues that can be found in our knowledge base. Have a look first as most basic questions are answered there.

<http://www.FlashForge.com>

The FlashForge support team can be reached by e-mail or phone between the hours of 8:00 a.m. to 5:00 p.m. PST Monday through Saturday. In case you contact us during off-duty time, your inquiry will be answered the following business day.

Note: Because of change different filament the extruder maybe blockaded. It's not owing to quality issue, and outside the scope of 400 hours life. If users encounter this problem, please contact our after-sale department and finish cleaning work according to their instruction.

Tel: [400-699-1063](tel:400-699-1063)

QQ: [2850862986](https://www.qq.com/number/2850862986) [2850863000](https://www.qq.com/number/2850863000) [2853382161](https://www.qq.com/number/2853382161)

ADD: [No. 518, Xianyuan Road, Jinhua, Zhejiang](#)

***When contacting support, please have your serial number ready.**

The serial number is a bar code on the back of your Dreamer

